

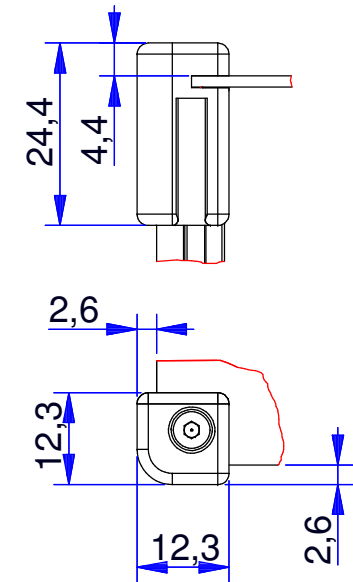

Detail Eckstück



B	mm
H	mm
T1	mm
T2	mm

 www.WoehrGmbH.de		Refer to protection notice ISO 16016 General tolerances ISO 2768 medium Not measured outlines take from the 3D- or dxf-data		Maßstab: 1:1	Gewicht:											
		<table border="1"> <thead> <tr> <th></th> <th>Datum</th> <th>Name</th> </tr> </thead> <tbody> <tr> <td>Bearb.</td> <td>28.06.2018</td> <td>M. Erlenmaier</td> </tr> <tr> <td>Gepr.</td> <td>28.06.2018</td> <td>A. Schwarz</td> </tr> <tr> <td>Norm</td> <td></td> <td></td> </tr> </tbody> </table>			Datum	Name	Bearb.	28.06.2018	M. Erlenmaier	Gepr.	28.06.2018	A. Schwarz	Norm			Baugruppe: Prioline KSK
	Datum	Name														
Bearb.	28.06.2018	M. Erlenmaier														
Gepr.	28.06.2018	A. Schwarz														
Norm																
		Bezeichnung: TISCHGEHÄUSE FORM II KSK														
		Artikel-Nr.:														
		Material:														
		Blatt 1														
		Bl.														
Zust.	Aenderung	Datum	Name	Urspr.	Ers. f.:											

Eckstückauswahl

Standard

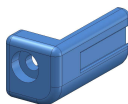

-RAL9005 (schwarz)	Art.-Nr. 1850003169
-RAL7016 (anthrazitgrau)	Art.-Nr. 1850003181
-RAL7035 (lichtgrau)	Art.-Nr. 1850003239
-RAL5017 (verkehrsblau)	Art.-Nr. 1850003168
-RAL5002 (ultramarinblau)	Art.-Nr. 1850003179
-RAL5018 (türkisblau)	Art.-Nr. 1850003183
-RAL3003 (rubinrot)	Art.-Nr. 1850003177
-RAL3020 (verkehrsrot)	Art.-Nr. 1850003170
-RAL1028 (melonengelb)	Art.-Nr. 1850003175
-RAL1023 (verkehrsgelb)	Art.-Nr. 1850003171

Seitenwand rechts

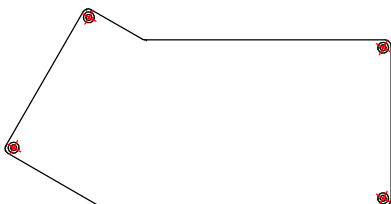

Seitenwand links

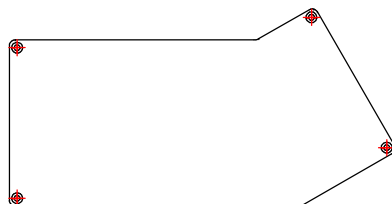

Bitte zeichnen Sie hier die gewünschte mechanische Bearbeitung ein.

natur eloxiert (Schnittkanten blank)	
lackiert RAL _____ Struktur	
pulverbeschichtet RAL _____ Struktur	

www.woehr-tabellen.industriegehaeuse.de/ral-tabellen/ral-farben

Frontplatte



Deckblech

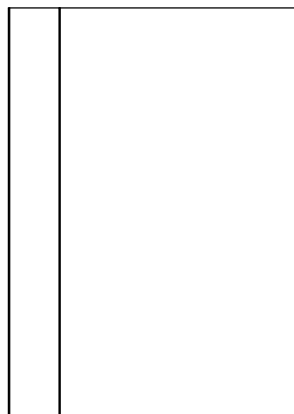

Rückplatte

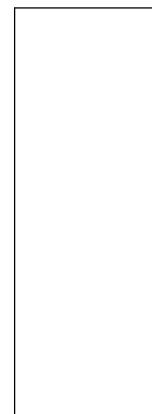

Bodenplatte

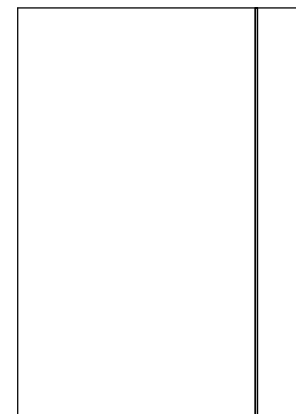

für Befestigungswinkel

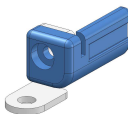

(Art.-Nr. 1800002952 / 1800002953)

-RAL9005 (schwarz)	Art.-Nr. 1850003173
-RAL7016 (anthrazitgrau)	Art.-Nr. 1850003182
-RAL7035 (lichtgrau)	Art.-Nr. 1850003240
-RAL5017 (verkehrsblau)	Art.-Nr. 1850003172
-RAL5002 (ultramarinblau)	Art.-Nr. 1850003180
-RAL5018 (türkisblau)	Art.-Nr. 1850003184
-RAL3003 (rubinrot)	Art.-Nr. 1850003178
-RAL3020 (verkehrsrot)	Art.-Nr. 1850003174
-RAL1028 (melonengelb)	Art.-Nr. 1850003176
-RAL1023 (verkehrsgelb)	Art.-Nr. 1850003242

 www.WoehrGmbH.de	Refer to protection notice ISO 16016 General tolerances ISO 2768 medium Not measured outlines take from the 3D- or dxf-data		Maßstab: 1:1	Gewicht:
			Baugruppe: Prioline KSK	Kunde: 169999
			Bezeichnung: TISCHGEHÄUSE FORM II KSK	
			Artikel-Nr.:	
			Material:	
			Blatt 2	
			Bl.	
Zust.	Änderung	Datum	Name	Urspr.
				Ers. f.: