

detail corner piece

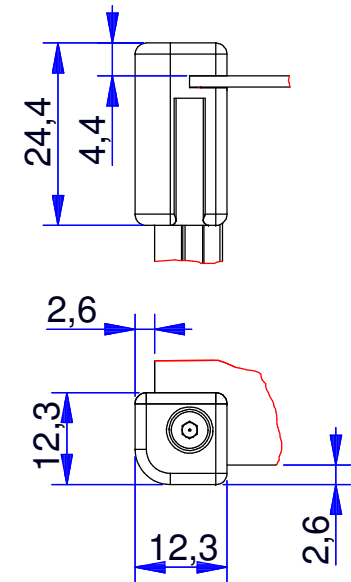

B	mm
H	mm
T1	mm
T2	mm

 www.WoehrGmbH.de		Refer to protection notice ISO 16016 General tolerances ISO 2768 medium Not measured outlines take from the 3D- or dxf-data		Maßstab: 1:1	Gewicht:
				Baugruppe:	Kunde:
				Prioline KSK	169999
				Bezeichnung:	
				TISCHGEHÄUSE FORM II KSK	
				Artikel-Nr.:	
				.	
				Material:	
				.	
				Urspr.	Ers. f.:
				sheet 1 Bl.	
Zust.	Änderung	Datum	Name		

Richard Wöhr GmbH
 D-75339 Höfen / Enz
 Richard@WoehrGmbH.de

	Datum	Name
Bearb.	28.06.2018	M. Erlenmaier
Gepr.	28.06.2018	A. Schwarz
Norm		

corner piece selection

right side panel

left side panel

Please enter here the desired mechanical processing.

standard

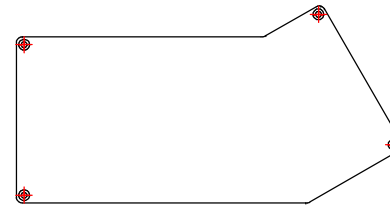
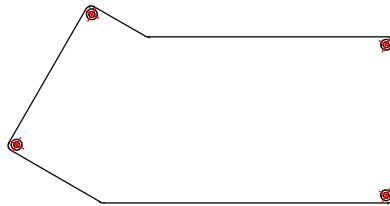
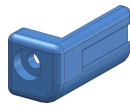

natural anodized (cut edges blank)	
painting RAL _____ structure	
powder-coated RAL _____ structure	

www.woehr-tabellen.industriehaeuse.de/en/ral-tabellen/ral-colors/

-RAL9005 (black) art.-No. 1850003169
-RAL7016 (anthracite grey) art.-No. 1850003181
-RAL7035 (light grey) art.-No. 1850003239
-RAL5017 (taffic blue) art.-No. 1850003168
-RAL5002 (ultramarine blue) art.-No. 1850003179
-RAL5018 (turquoise blue) art.-No. 1850003183
-RAL3003 (ruby red) art.-No. 1850003177
-RAL3020 (traffic red) art.-No. 1850003170
-RAL1028 (melon yellow) art.-No. 1850003175
-RAL1023 (traffic yellow) art.-No. 1850003171

front panel

cover panel

back panel

base plate

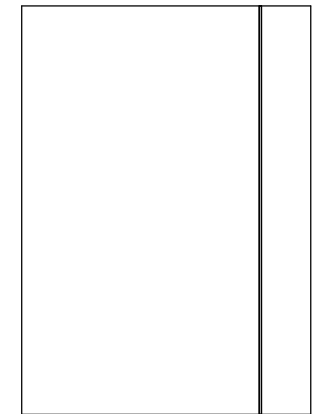
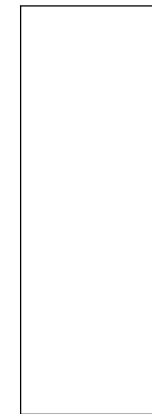
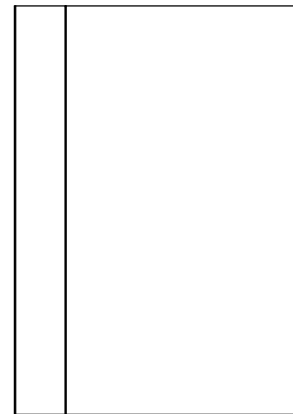
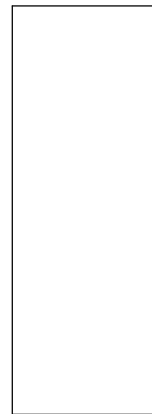

for mounting brackets

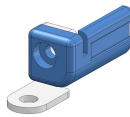

(art.-No. 1800002952 / 1800002953)

-RAL9005 (black) art.-No. 1850003173
-RAL7016 (anthracite grey) art.-No. 1850003182
-RAL7035 (light grey) art.-No. 1850003240
-RAL5017 (taffic blue) art.-No. 1850003172
-RAL5002 (ultramarine blue) art.-No. 1850003180
-RAL5018 (turquoise blue) art.-No. 1850003184
-RAL3003 (ruby red) art.-No. 1850003178
-RAL3020 (traffic red) art.-No. 1850003174
-RAL1028 (melon yellow) art.-No. 1850003176
-RAL1023 (traffic yellow) art.-No. 1850003242

 www.WoehrGmbH.de	Refer to protection notice ISO 16016 General tolerances ISO 2768 medium Not measured outlines take from the 3D- or dxf-data		Maßstab: 1:1	Gewicht:
			Baugruppe: Prioline KSK	Kunde: 169999
		Bezeichnung: TISCHGEHÄUSE FORM II KSK		
		Artikel-Nr.:		
		Material:		
		sheet 2		
		Bl.		
Zust.	Änderung	Datum	Name	Urspr.
				Ers. f.: