

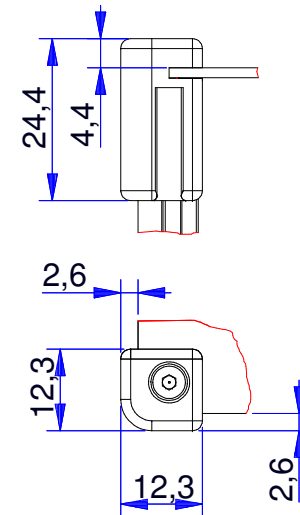

Detail Eckstück



B	mm
H1	mm
H2	mm
T	mm

 www.WoehrGmbH.de		Refer to protection notice ISO 16016 General tolerances ISO 2768 medium Not measured outlines take from the 3D- or dxf-data		Maßstab: 1:1	Gewicht:												
				Baugruppe: Prioline KSK	Kunde: 169999												
		<table border="1"> <thead> <tr> <th></th> <th>Datum</th> <th>Name</th> </tr> </thead> <tbody> <tr> <td>Bearb.</td> <td>07.06.2018</td> <td>M. Erlenmaier</td> </tr> <tr> <td>Gepr.</td> <td>07.06.2018</td> <td>A. Schiele</td> </tr> <tr> <td>Norm</td> <td></td> <td></td> </tr> </tbody> </table>			Datum	Name	Bearb.	07.06.2018	M. Erlenmaier	Gepr.	07.06.2018	A. Schiele	Norm			Bezeichnung: PULTGEHÄUSE FORM I KSK	
	Datum	Name															
Bearb.	07.06.2018	M. Erlenmaier															
Gepr.	07.06.2018	A. Schiele															
Norm																	
				Artikel-Nr.:													
		Richard Wöhr GmbH D-75339 Höfen / Enz Richard@WoehrGmbH.de		Material:													
				Blatt 1													
				Ers. f.:													
Zust.	Änderung	Datum	Name														

Eckstückauswahl

Standard

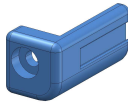

-RAL9005 (schwarz)	Art.-Nr. 1850003169
-RAL7016 (anthrazitgrau)	Art.-Nr. 1850003181
-RAL7035 (lichtgrau)	Art.-Nr. 1850003239
-RAL5017 (verkehrsblau)	Art.-Nr. 1850003168
-RAL5002 (ultramarinblau)	Art.-Nr. 1850003179
-RAL5018 (türkisblau)	Art.-Nr. 1850003183
-RAL3003 (rubinrot)	Art.-Nr. 1850003177
-RAL3020 (verkehrsrot)	Art.-Nr. 1850003170
-RAL1028 (melonengelb)	Art.-Nr. 1850003175
-RAL1023 (verkehrsgelb)	Art.-Nr. 1850003171

für Befestigungswinkel

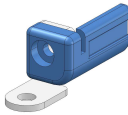

(Art.-Nr. 1800002952 / 1800002953)

-RAL9005 (schwarz)	Art.-Nr. 1850003173
-RAL7016 (anthrazitgrau)	Art.-Nr. 1850003182
-RAL7035 (lichtgrau)	Art.-Nr. 1850003240
-RAL5017 (verkehrsblau)	Art.-Nr. 1850003172
-RAL5002 (ultramarinblau)	Art.-Nr. 1850003180
-RAL5018 (türkisblau)	Art.-Nr. 1850003184
-RAL3003 (rubinrot)	Art.-Nr. 1850003178
-RAL3020 (verkehrsrot)	Art.-Nr. 1850003174
-RAL1028 (melonengelb)	Art.-Nr. 1850003176
-RAL1023 (verkehrsgelb)	Art.-Nr. 1850003242

Seitenwand rechts

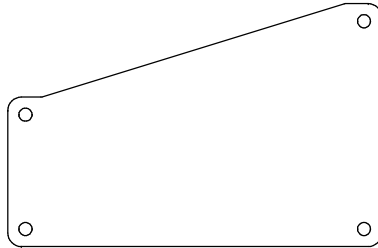

Seitenwand links

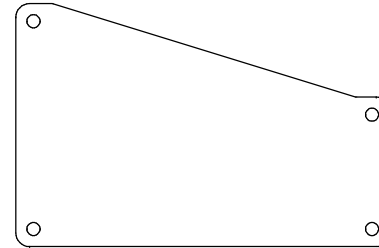

Bitte zeichnen Sie hier die gewünschte mechanische Bearbeitung ein.

natur eloxiert (Schnittkanten blank)	
lackiert RAL _____ Struktur	
pulverbeschichtet RAL _____ Struktur	

www.woehr-tabellen.industriegehaeuse.de/ral-tabellen/ral-farben

Frontplatte



Deckblech

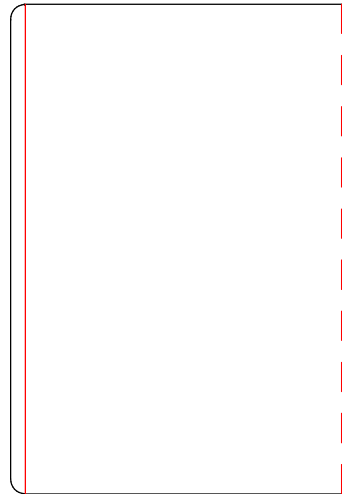

Rückplatte

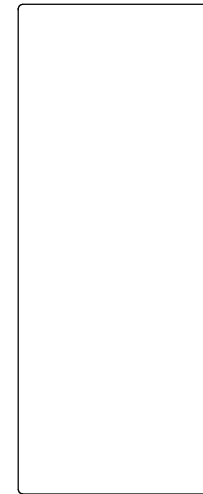

Bodenplatte

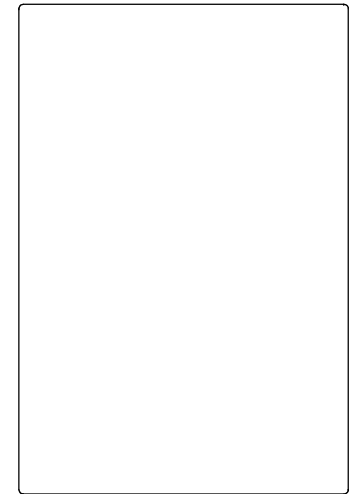

 www.WoehrGmbH.de	Refer to protection notice ISO 16016 General tolerances ISO 2768 medium Not measured outlines take from the 3D- or dxf-data		Maßstab: 1:1	Gewicht:
			Baugruppe: Prioline KSK	Kunde: 169999
			Bezeichnung: PULTGEHÄUSE FORM I KSK	
			Artikel-Nr.:	
			Material:	
			Blatt 2	
			Bl.	
Zust.	Änderung	Datum	Name	Urspr.
				Ers. f.: