

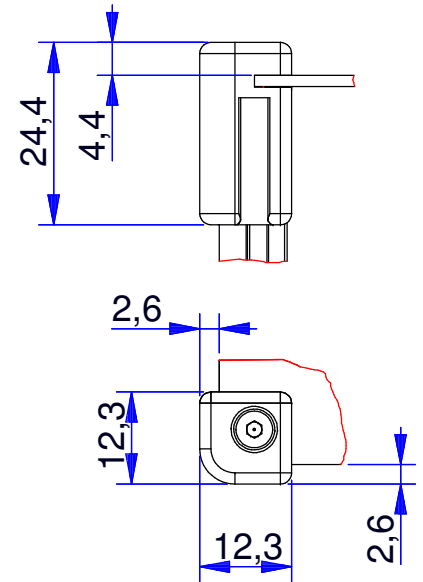

detail corner piece



B	mm
H1	mm
H2	mm
T1	mm
T2	mm

 www.WoehrGmbH.de	Refer to protection notice ISO 16016 General tolerances ISO 2768 medium Not measured outlines take from the 3D- or dxf-data		Maßstab: 1:1	Gewicht:
			Baugruppe:	Kunde:
			Prioline KSK	169999
			Bezeichnung: PULTGEHÄUSE FORM II KSK	
			Artikel-Nr.:	
			Material:	
			sheet 1	
			Bl.	
Zust.	Änderung	Datum	Name	Urspr.
				Ers. f.:

corner piece selection

standard

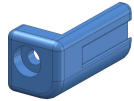

-RAL9005 (black) art.-No. 1850003169
-RAL7016 (anthracite grey) art.-No. 1850003181
-RAL7035 (light grey) art.-No. 1850003239
-RAL5017 (taffic blue) art.-No. 1850003168
-RAL5002 (ultramarine blue) art.-No. 1850003179
-RAL5018 (turquoise blue) art.-No. 1850003183
-RAL3003 (ruby red) art.-No. 1850003177
-RAL3020 (traffic red) art.-No. 1850003170
-RAL1028 (melon yellow) art.-No. 1850003175
-RAL1023 (traffic yellow) art.-No. 1850003171

right side panel

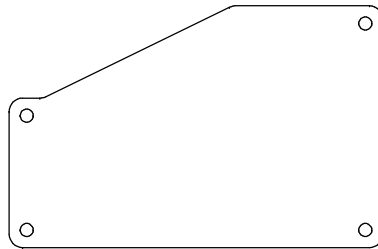

left side panel

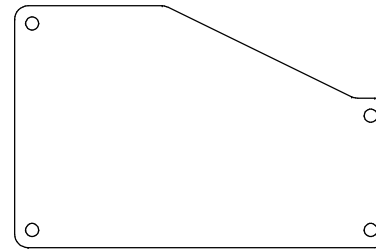

Please enter here the desired mechanical processing.

natural anodized (cut edges blank)	
paintd RAL _____ structure	
powder-coated RAL _____ structure	

www.woehr-tabellen.industriegehaeuse.de/en/ral-tabellen/ral-colors/

front panel

cover panel

back panel

base plate

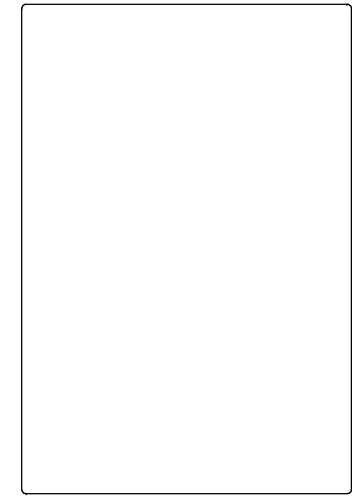
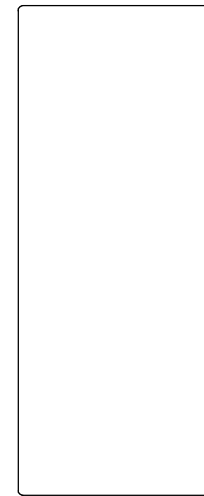
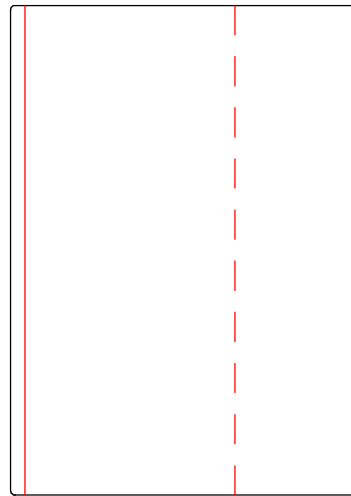

for mounting brackets



(art.-No. 1800002952 / 1800002953)

-RAL9005 (black) art.-No. 1850003173
-RAL7016 (anthracite grey) art.-No. 1850003182
-RAL7035 (light grey) art.-No. 1850003240
-RAL5017 (taffic blue) art.-No. 1850003172
-RAL5002 (ultramarine blue) art.-No. 1850003180
-RAL5018 (turquoise blue) art.-No. 1850003184
-RAL3003 (ruby red) art.-No. 1850003178
-RAL3020 (traffic red) art.-No. 1850003174
-RAL1028 (melon yellow) art.-No. 1850003176
-RAL1023 (traffic yellow) art.-No. 1850003242

 www.WoehrGmbH.de	Refer to protection notice ISO 16016 General tolerances ISO 2768 medium Not measured outlines take from the 3D- or dxf-data		Maßstab: 1:1	Gewicht:
			Baugruppe: Prioline KSK	Kunde: 169999
		Bezeichnung: PULTGEHÄUSE FORM II KSK		
		Artikel-Nr.:		
		Material:		sheet 2
		Urspr.		Bl.
Zust.	Anderung	Datum	Name	Ers. f.: