

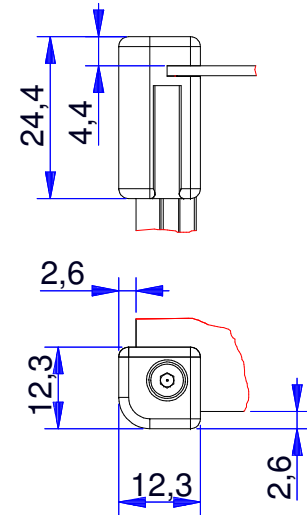

detail corner piece



B	mm
H1	mm
H2	mm
T	mm

 www.WoehrGmbH.de		Refer to protection notice ISO 16016 General tolerances ISO 2768 medium Not measured outlines take from the 3D- or dxf-data		Maßstab: 1:1	Gewicht:												
				Baugruppe: Prioline KSK	Kunde: 169999												
		<table border="1"> <thead> <tr> <th></th> <th>Datum</th> <th>Name</th> </tr> </thead> <tbody> <tr> <td>Bearb.</td> <td>07.06.2018</td> <td>M. Erlenmaier</td> </tr> <tr> <td>Gepr.</td> <td>07.06.2018</td> <td>A. Schiele</td> </tr> <tr> <td>Norm</td> <td></td> <td></td> </tr> </tbody> </table>			Datum	Name	Bearb.	07.06.2018	M. Erlenmaier	Gepr.	07.06.2018	A. Schiele	Norm			Bezeichnung: PULTGEHÄUSE FORM I KSK	
	Datum	Name															
Bearb.	07.06.2018	M. Erlenmaier															
Gepr.	07.06.2018	A. Schiele															
Norm																	
		Artikel-Nr.:		Material:													
		Richard Wöhr GmbH D-75339 Höfen / Enz Richard@WoehrGmbH.de		sheet 1													
		Zust. Änderung Datum Name		Ers. f.:													

16.11.2018

corner piece selection

right side panel

left side panel

Please enter here the desired mechanical processing.

standard

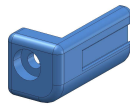

-RAL9005 (black) art.-No. 1850003169
-RAL7016 (anthracite grey) art.-No. 1850003181
-RAL7035 (light grey) art.-No. 1850003239
-RAL5017 (taffic blue) art.-No. 1850003168
-RAL5002 (ultramarine blue) art.-No. 1850003179
-RAL5018 (turquoise blue) art.-No. 1850003183
-RAL3003 (ruby red) art.-No. 1850003177
-RAL3020 (traffic red) art.-No. 1850003170
-RAL1028 (melon yellow) art.-No. 1850003175
-RAL1023 (traffic yellow) art.-No. 1850003171

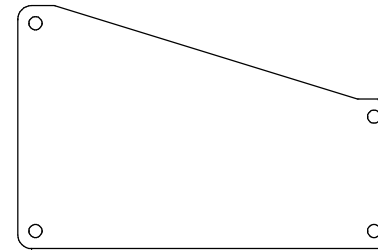
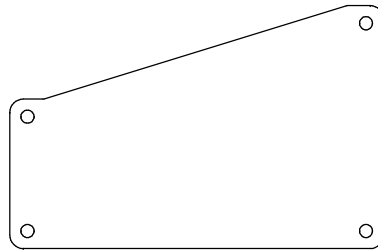

natural anodized (cut edges blank)	
painting RAL _____ structure	
powder-coated RAL _____ structure	

www.woehr-tabellen.industriegehaeuse.de/en/ral-tabellen/ral-colors/

front panel

cover panel

back panel

base plate

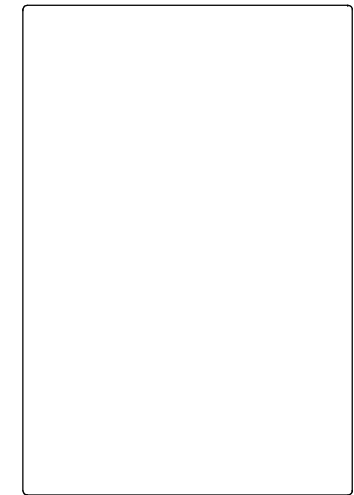
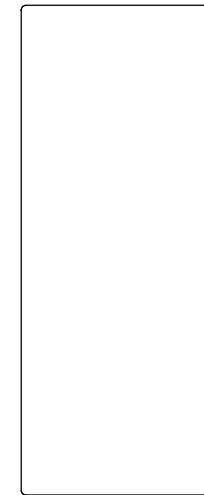
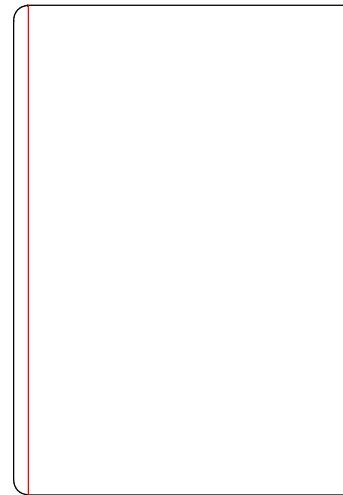

for mounting brackets

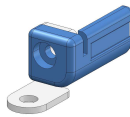

(art.-No. 1800002952 / 1800002953)

-RAL9005 (black) art.-No. 1850003173
-RAL7016 (anthracite grey) art.-No. 1850003182
-RAL7035 (light grey) art.-No. 1850003240
-RAL5017 (taffic blue) art.-No. 1850003172
-RAL5002 (ultramarine blue) art.-No. 1850003180
-RAL5018 (turquoise blue) art.-No. 1850003184
-RAL3003 (ruby red) art.-No. 1850003178
-RAL3020 (traffic red) art.-No. 1850003174
-RAL1028 (melon yellow) art.-No. 1850003176
-RAL1023 (traffic yellow) art.-No. 1850003242

 www.WoehrGmbH.de	Refer to protection notice ISO 16016 General tolerances ISO 2768 medium Not measured outlines take from the 3D- or dxf-data		Maßstab: 1:1	Gewicht:
			Baugruppe:	Kunde:
			Prioline KSK	169999
		Bezeichnung:	PULTGEHÄUSE FORM I KSK	
		Artikel-Nr.:	.	
		Material:	sheet 2 Bl.	
Zust.	Änderung	Datum	Urspr.	Ers. f.: