

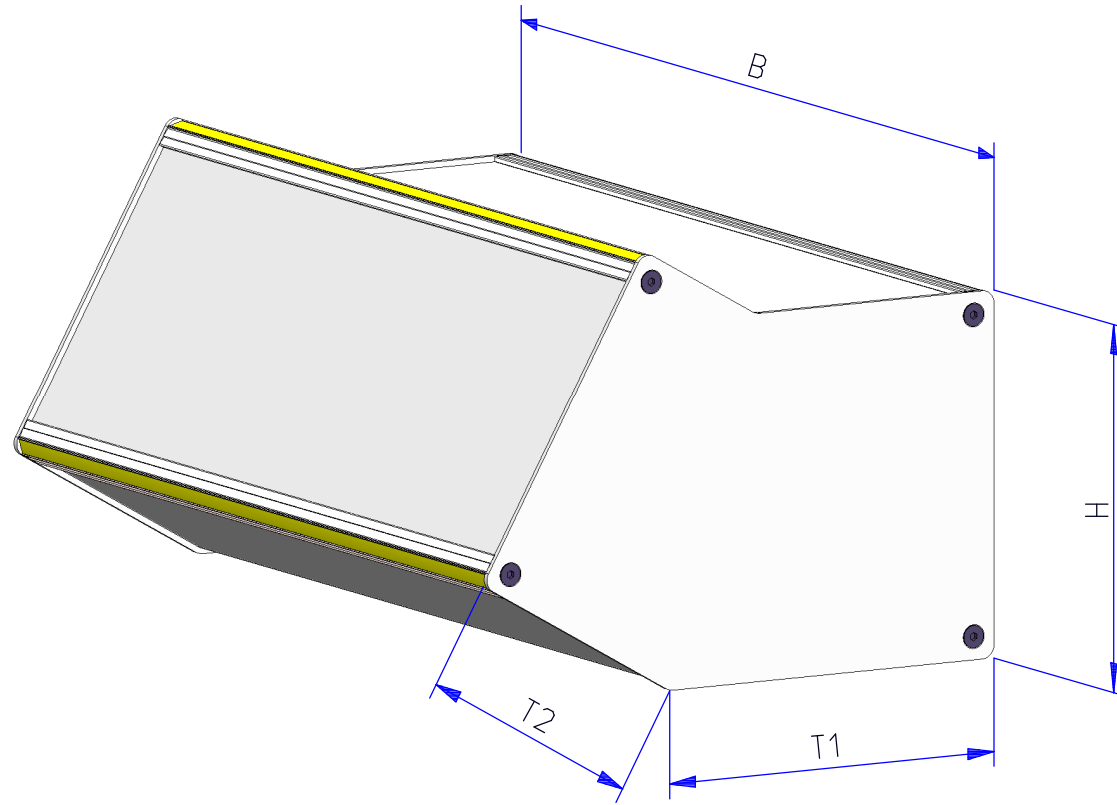

Die Designstreifen sind in den Standardfarben:

RAL5018 (türkisblau)	
RAL7035 (lichtgrau)	
RAL9005 (schwarz)	
RAL9006 (weißaluminium)	
RAL9010 (reinweiß)	

erhältlich.



B		mm
H		mm
T1		mm
T2		mm

 www.WoehrGmbH.de	Refer to protection notice ISO 16016 General tolerances ISO 2768 medium Not measured outlines take from the 3D- or dxf-data		Maßstab: 1:1	Gewicht:
			Baugruppe: Prioline	Kunde: 169999
			Bezeichnung: TISCHGEHÄUSE FORM II D1	
			Artikel-Nr.:	
			Material:	
			Blatt 1 Bl.	
Zust.	Änderung	Datum	Name	Urspr.
				Ers. f.:

Bitte tragen Sie hier die gewünschte mechanische Bearbeitung ein.

Seitenwand rechts

Seitenwand links

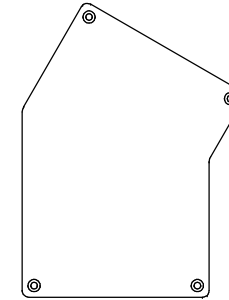
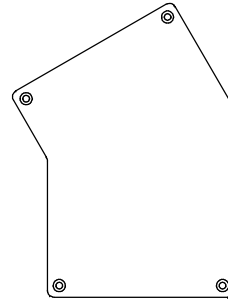

Frontplatte

Deckblech

Rückplatte

Bodenplatte

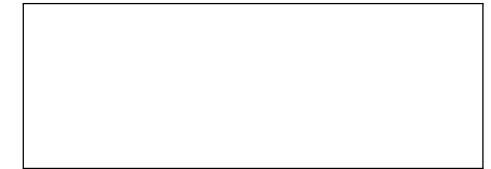
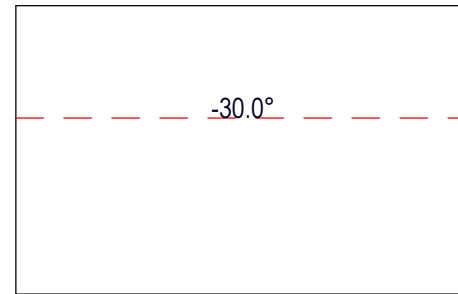
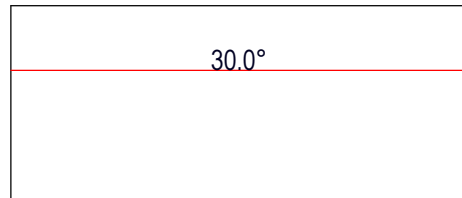

natur eloxiert (Schnittkanten blank)	
lackiert RAL _____ Struktur	
pulverbeschichtet RAL _____ Struktur	

www.woehr-tabellen.industriegehaeuse.de/ral-tabellen/ral-farben

 RICHARD WÖHR <small>GMBH</small> www.WoehrGmbH.de	Refer to protection notice ISO 16016 General tolerances ISO 2768 medium Not measured outlines take from the 3D- or dxf-data		Maßstab: 1:1	Gewicht:
			Baugruppe: Prioline	Kunde: 169999
			Bezeichnung: TISCHGEHÄUSE FORM II D1	
			Artikel-Nr.:	
			Material:	
			Urspr.	Ers. f.:
			Blatt 2 Bl.	
Zust.	Änderung	Datum	Name	