

B = \_\_\_\_\_ mm

H = \_\_\_\_\_ mm

T1 = \_\_\_\_\_ mm

T2 = \_\_\_\_\_ mm

Detail Eckstück

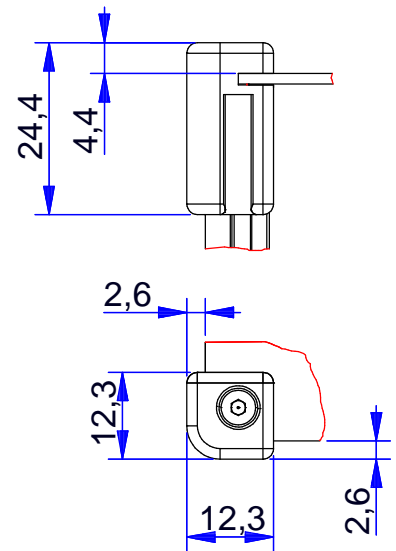

 www.WoehrGmbH.de						Maßstab: 1:2	Gewicht:
				Bearb.	Datum	Name	Prioline KSK KD: 169999 PULTGEHÄUSE FORM VI KSK
				Gepr.			
				Norm			
				Richard Wöhr GmbH D-75339 Höfen / Enz Richard@WoehrGmbH.de			Blatt 1
Zust.	Änderung	Datum	Name	Urspr.	Ers. f.:	Ers. d.:	Bl.

Seitenwand rechts

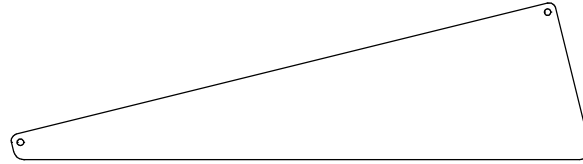

Seitenwand links

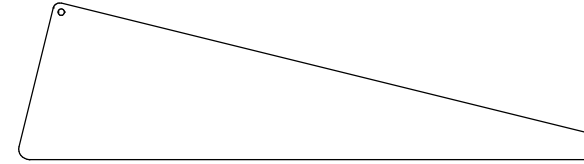

Deckblech

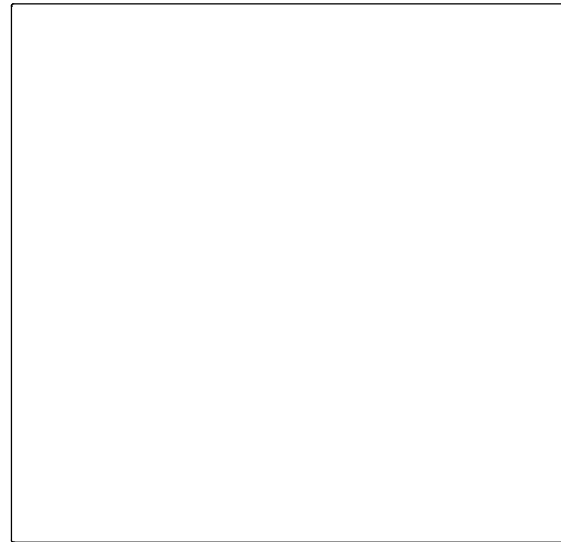

Bodenblech / Rückblech

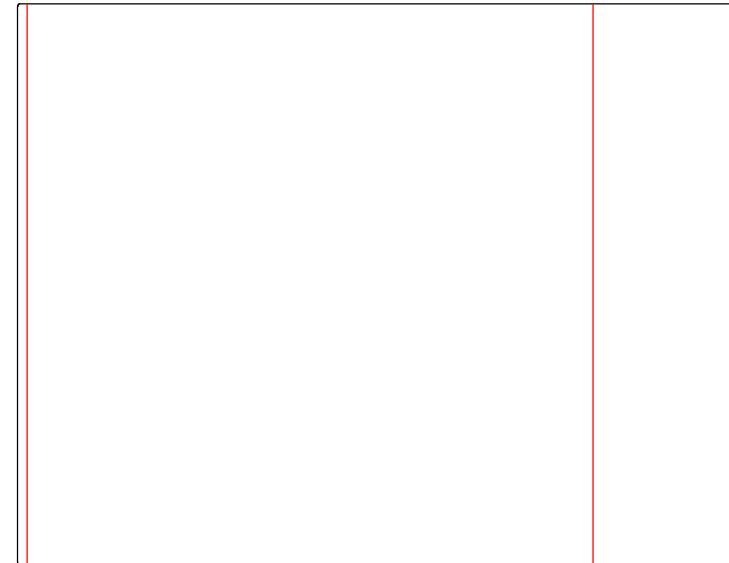

B = \_\_\_\_\_ mm

H = \_\_\_\_\_ mm

T1 = \_\_\_\_\_ mm

T2 = \_\_\_\_\_ mm

 www.WoehrGmbH.de				Maßstab: 1:2.5		Gewicht:	
				Schutzvermerk nach DIN 16016 beachten / Freimasstoleranzen nach DIN 7168 mittel Not measured outlines take from the 3D- or dxf-data			
				Datum	Name	Prioline KSK KD: 169999	
				Bearb.	19.01.2015	A. Schwarz	PULTGEHÄUSE FORM VI KSK
				Gepr.			
				Norm			
				Richard Wöhr GmbH			Material:
				D-75339 Höfen / Enz			
				Richard@WoehrGmbH.de			Blatt 1 Bl.
Zust.	Änderung	Datum	Name	Urspr.	Ers. f.:	Ers. d.:	