

B = _____ mm
 H1 = _____ mm
 H2 = _____ mm
 T1 = _____ mm
 T2 = _____ mm
 T3 = _____ mm

Detail Eckstück

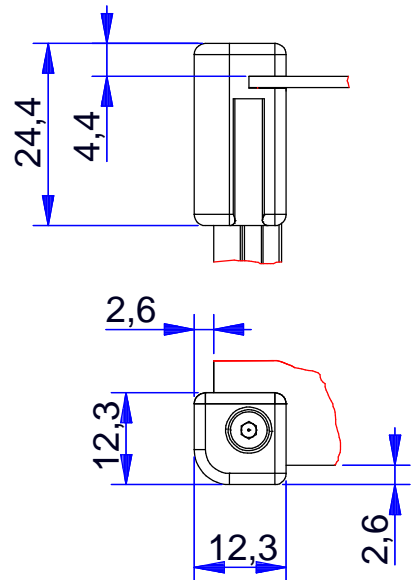

 RICHARD WÖHR <small>GMBH</small> www.WoehrGmbH.de				Maßstab: 1: 2.5		Gewicht:	
				Schutzvermerk nach DIN 16016 beachten / Freimasstoleranzen nach DIN 7168 mittel Not measured outlines take from the 3D- or dxf-data			
				Bearb.	Datum	Name	Prioline KSK KD: 169999 2 KAMMERGEHÄUSE FORM VIII KSK
				Gepr.	19.01.2015	A. Schwarz	
				Norm			
				Richard Wöhr GmbH D-75339 Höfen / Enz Richard@WoehrGmbH.de			Material:
Zust.	Änderung	Datum	Name	Urspr.	Ers. f.:	Ers. d.:	
							Blatt 1 Bl.

Seitenwand rechts

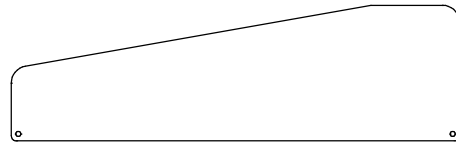

Seitenwand links

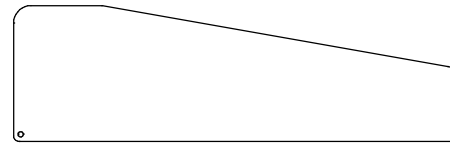

Deckblech vorne

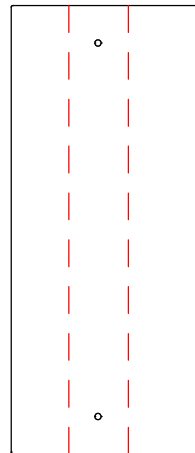

Deckblech

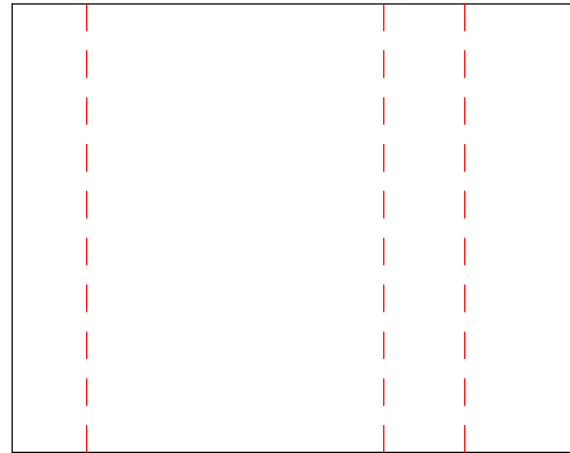

Bodenplatte

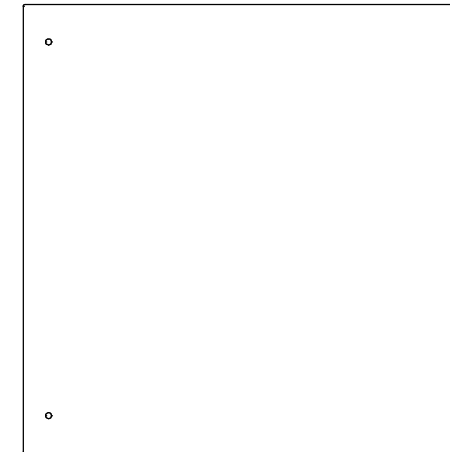

B = _____ mm

H1 = _____ mm

H2 = _____ mm

T1 = _____ mm

T2 = _____ mm

T3 = _____ mm

 RICHARD WÖHR GmbH www.WoehrGmbH.de				Maßstab: 1:5		Gewicht:	
				Schutzvermerk nach DIN 16016 beachten / Freimasstoleranzen nach DIN 7168 mittel Not measured outlines take from the 3D- or dxf-data			
				Datum	Name	Prioline KSK KD: 169999	
				Bearb.	19.01.2015	A. Schwarz	
				Gepr.			
				Norm		2 KAMMERGEHÄUSE FORM VIII KSK	
				Richard Wöhr GmbH D-75339 Höfen / Enz Richard@WoehrGmbH.de			Material:
						Blatt 1	
						Bl.	
Zust.	Änderung	Datum	Name	Urspr.	Ers. f.:	Ers. d.:	